



DTQA SUPPLY AIR DIFFUSER

AIR MANAGEMENT SYSTEMS

PRODUCT PROPERTIES

DTQA is a very quiet supply air diffuser which is suitable for air distribution in offices, houses and rooms where wall mounting is required. It can be mounted on wall and also close to the ceiling. DTQA has a removable front plate for easy cleaning, measuring and adjustment of air flow.

Product facts

- Low noise level
- Can be mounted close to the ceiling
- Removable front plate for easy cleaning, measuring and adjustment of air flow

Quick selection when 8 open rows

Diffuser	Connection	Air flow l/s (m ³ /h) and noise level		
Size	mm	25 dB(A)	30 dB(A)	35 dB(A)
DTQA100	100	17	20(72)	24
DTQA125	125	20	24(86)	28

Air flow, pressure drop, sound level, throw

DTQA100

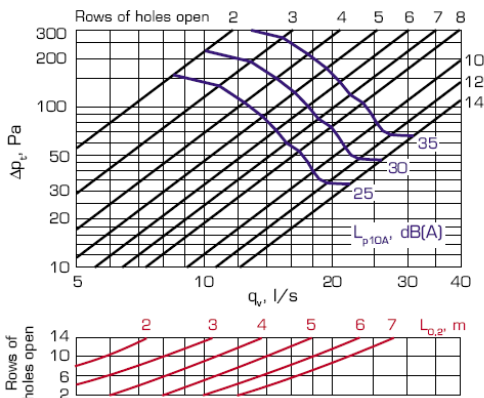

DTQA125

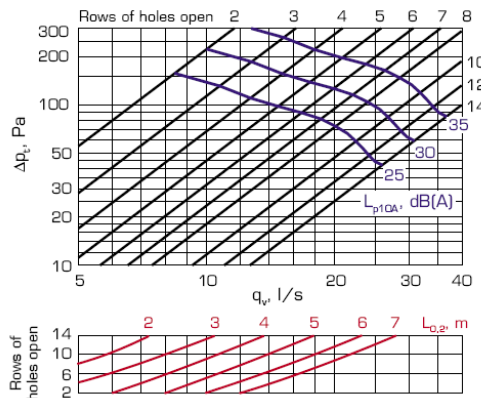

Sound power level L_w

STQA	CORRECTION K _{cor} (dB)						
	125	250	500	1000	2000	4000	8000
100	-1	-4	0	0	-2	-11	-14
125	2	-3	-2	-1	-1	-8	-13
Toler. ±	3	2	2	2	2	2	3

Effect of distance X and open rows of holes to the noise level at different connections

Ø100	Rows of holes open					
	14	8	2	14	8	2
X						
4D	+0 dB	+2 dB	+0 dB	+2 dB	+0 dB	+0 dB
2D	+3 dB	+4 dB	+2 dB	+4 dB	+0 dB	+0 dB
0D	+4 dB	+6 dB	+3 dB	+5 dB	+0 dB	+0 dB

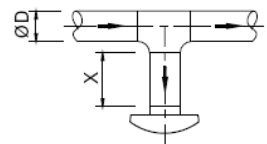

Sound attenuation ΔL

STQA	Rows of holes open	SOUND ATTENUATION ΔL (dB)							
		Middle frequency by octave band (Hz)							
		63	125	250	500	1000	2000	4000	8000
100	14	19	13	8	0	0	1	3	3
	8	19	13	7	0	0	4	5	5
	2	19	14	7	7	10	7	9	12
125	14	17	12	6	0	0	1	2	3
	8	17	12	6	1	2	4	5	5
	2	19	14	8	8	10	7	10	11
Toler. ±		6	3	2	2	2	2	2	3

Ø125	Rows of holes open					
	14	8	2	14	8	2
X						
4D	+0 dB	+0 dB	+0 dB	+0 dB	+0 dB	+0 dB
2D	+2 dB	+3 dB	+2 dB	+3 dB	+0 dB	+0 dB
0D	+3 dB	+4 dB	+3 dB	+4 dB	+0 dB	+0 dB

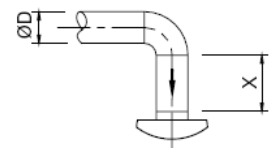

LIABILITY:

The information contained in this brochure was current on the publication date. DEC INTERNATIONAL reserves the right to make changes in details at any time without prior notice. In order to avoid misunderstandings, any interested party is advised to contact DEC INTERNATIONAL checking for any changes in materials and/or information after this brochure was published.

PLEASE NOTICE:

The consultant is responsible for the actual installation and mounting of the product. The mentioned values with respect to temperatures are not appropriate to be used to determine the physical properties. These properties are also dependent on humidity and the temperature of the air inside and outside of the H.V.A.C. system.

TRADEMARKS:

DEC International and the DEC logo are trademarks, or registered trademarks of Dutch Environment Corporation BV in the Netherlands and/or other countries.



DTQA SUPPLY AIR DIFFUSER

AIR MANAGEMENT SYSTEMS

Diffusion pattern, dimensions, installation

Diffusion pattern

From top

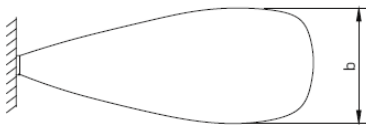

From side

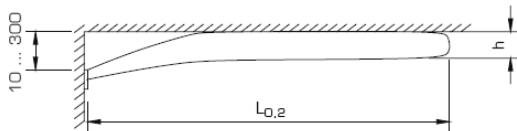

Installation

DTQA is mounted straight to the duct without mounting ring. Fastening is secured with screws to the wall or with pop rivets to the duct. Front plate is fastened to the body with spring clips.

Measuring and adjustment of the air flow

Air flow measurement is made by measuring the pressure difference from the front plate hole. Adjustment of the air volume is obtained by opening and closing the rows of front plate holes.

Trow when chilled air is obtained by correction factor k according to the following formula: $L_{0,2(t)} = k \times L_{0,2}$

T (°C)	B	h	K
0	$0,6 \times L_{0,2}$	$0,07 \times L_{0,2}$	1,0
-7	$0,8 \times L_{0,2}$	$0,15 \times L_{0,2}$	0,7

Dimensions and weight

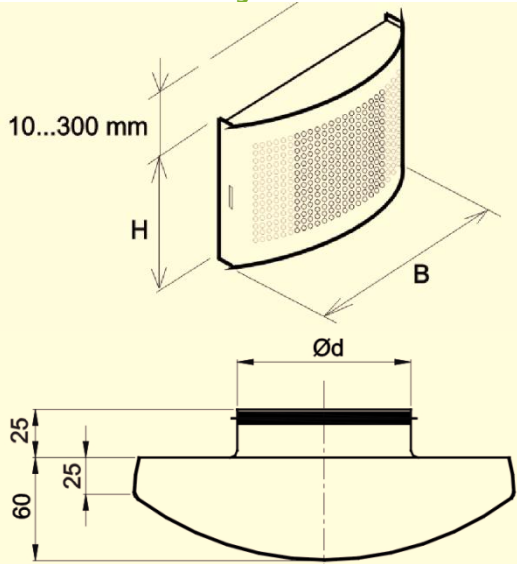

Size	Ød	B x H	W (kg)
100	98	218x156	0.66
125	123	218x156	0.65

Application and function

DTQA is a very quiet supply air diffuser which can be mounted on wall and also close to the ceiling. It is suitable for air distribution in offices, houses and rooms where wall mounting is required. DTQA has a removable front plate for easy cleaning, measuring and adjustment of air flow. The body of DTQA is equipped with circular rubber sealing gasket joint.

Material and surface finish

The diffuser is made of hot-dip galvanized steel sheet, SS 1151, and meets the requirements for corrosivity class C2 in accordance with SS-EN ISO 12944-2.

The diffusers are powder-coated, which gives a high surface finish and good impact and scratch resistance. Standard color is white RAL 9010, gloss 70. Other colors are available to special order.

Also available in stainless steel shiny 1.4301 (DTQAY)



Instructions

Instructions for installation, adjustment and maintenance are described in detail in our technical instructions, which are supplied with every product.

LIABILITY:

The information contained in this brochure was current on the publication date. DEC INTERNATIONAL reserves the right to make changes in details at any time without prior notice. In order to avoid misunderstandings, any interested party is advised to contact DEC INTERNATIONAL checking for any changes in materials and/or information after this brochure was published.

PLEASE NOTICE:

The consultant is responsible for the actual installation and mounting of the product. The mentioned values with respect to temperatures are not appropriate to be used to determine the physical properties. These properties are also dependent on humidity and the temperature of the air inside and outside of the H.V.A.C. system.

TRADEMARKS:

DEC International and the DEC logo are trademarks, or registered trademarks of Dutch Environment Corporation BV in the Netherlands and/or other countries.